

KENTON

PRO SOLO *mk3*

HIGH SPEC MIDI TO CV CONVERTER

IN — MIDI — THRU (SYNC24) AUX3 AUX2 AUX1 GATE (S-TRIG) CV (Hz/V) DC IN 9V

high specification single channel midi to cv converter

▢ PARA ▢ VAL ▢ GATE

▢ ▢ ▢
SELECT DEC INC
PARAMETER / VALUE TOGGLE
LONG HOLD TO STORE

PRO SOLO Mk3

KENTON
www.kenton.co.uk

MAIN PARAMETERS ONLY LISTED BELOW

GENERAL	01	MIDI RECEIVE CHANNEL	0
NOTE	02	RETRIG TIME	
	03	NOTE PRIORITY LO/HI/NEW	
	04	PITCHBEND RANGE	
	06	PORTAMENTO TIME / RATE	
	07	PORTAMENTO TYPE	
	12	COARSE TUNE (SEMITONES)	
	13	FINE TUNE	
	14	SCALE	
	15	CV/HZ SELECT	
	16	GATE TYPE SELECT	
AUX 1	20	CONTROLLER #	
	21	MINIMUM VALUE	
	22	MAXIMUM VALUE	
	23	RESET VALUE	
	24	KEY SCALE TO AUX 1	
AUX 2	30	CONTROLLER #	
AUX 3	40	CONTROLLER #	
LFO	50	LFO RATE	
CLK1	60	DIVIDE	
CLK2	70	DIVIDE	
OTHER	90	SOCKET SELECT	
	98	LOAD	
	99	STORE	

0 1

CE

Operating Manual

FCC STATEMENT FOR PRO SOLO Mk3:

NOTE: This equipment has been tested and found to comply with the limits for a Class B digital device, pursuant to Part 15 of the FCC Rules. These limits are designed to provide reasonable protection against harmful interference in a residential installation. This equipment generates, uses and can radiate radio frequency energy and, if not installed and used in accordance with the instructions, may cause harmful interference to radio communications. However, there is no guarantee that interference will not occur in a particular installation. If this equipment does cause harmful interference to radio or television reception, which can be determined by turning the equipment off and on, the user is encouraged to try to correct the interference by one or more of the following measures:

- Reorient or relocate the receiving antenna.
- Increase the separation between the equipment and receiver.
- Connect the equipment into an outlet on a circuit different from that to which the receiver is connected.
- Consult the dealer or an experienced radio/TV technician for help.

WEEE DIRECTIVE:

(applies to the European Union & other European countries with separate collection systems)

The crossed-out wheelee bin symbol affixed to this product indicates that it should not be disposed of with other household wastes at the end of its working life. To prevent possible harm to the environment or to human health from uncontrolled waste disposal, please separate this from other types of wastes and recycle it responsibly to promote the sustainable re-use of material resources.

Household users should contact either the retailer where they purchased the product, or their local government office for details of where and how they can take this item for environmentally safe recycling. Business users should contact their supplier and check the terms and conditions of the purchase contract. This product should not be mixed with other commercial wastes for disposal.

EU PRODUCT SAFETY REPRESENTATIVES:

(applies to the European Union & Northern Ireland)

Manufacturer:
Kenton Electronics Ltd
Unit 3 Epsom Downs Metro Centre
Waterfield
Tadworth
KT20 5LR
United Kingdom

www.kenton.co.uk
EC Representative:
Alex4 Distribution GmbH
Lessingstr. 98, 100 – Haus 11
13158 Berlin
Germany
www.alex4.de

Contents

Introduction

Connections	4
System Diagram	5

Getting Started

Editing Parameters	6
Loading & Storing Setups	7
Setting Up Your Synth	8
Using the Aux Outputs	9
Using the LFO	10
Using the ADSR Envelope Generator	11
Using the Drum & Note Triggers	12
Using the Clock Outputs	13

Parameter List

General & Note	14
Aux 1	17
Aux 2	19
Aux 3	20
LFO	21
Clock	23
ADSR Envelope Generator	24
Other	25

Appendix

Factory Defaults & Synth Settings	27
Firmware Upgrade	28
MIDI Analyser Mode	29
MIDI Implementation	30
Specification / Warranty	31

Introduction

Congratulations on your purchase. The PRO SOLO Mk3 is a high specification, extremely accurate and flexible MIDI to Control Voltage converter. This new third version of our long-running PRO SOLO series now includes additional auxiliary outputs, a built-in ADSR envelope generator and the ability to generate trigger outputs for drum synthesizers.

Connections

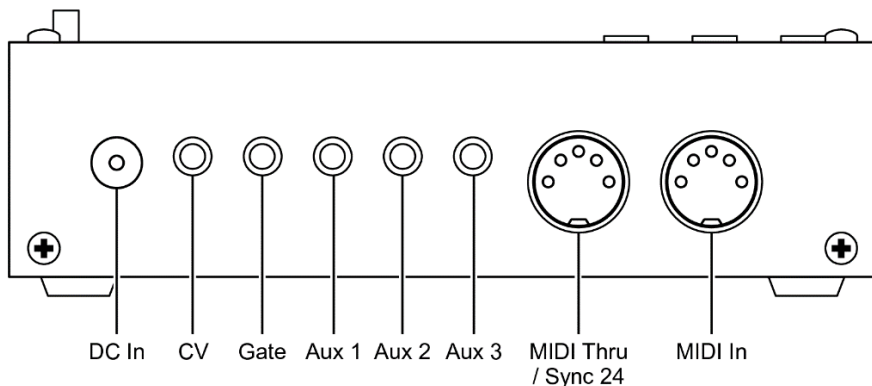

MIDI IN

Plug your MIDI keyboard or sequencer's output in here.

MIDI THRU / SYNC 24

Software selectable to operate either as a MIDI Thru or as a Sync 24 port (also known as DIN-SYNC), for clocking vintage drum machines etc.

CV

Plug this into your synthesizer's input marked CV IN, VCO IN, KYBD IN, etc. This voltage controls the pitch of the oscillator(s) on your synthesizer.

GATE

Plug this into your synthesizer's input marked GATE, V-TRIG, S-TRIG, etc. This signal turns the note on and off on your synthesizer.

AUX 1, 2 & 3

The Aux outputs can be assigned to many different things on the PRO SOLO Mk3, but are commonly used to connect to filter, volume or clock inputs on a synthesizer.

DC IN 9V

Plug the supplied power adapter in here. (9V DC @ 100mA, 2.1mm connector, centre positive)

WARNING!

Do not use an adapter with a voltage output of more than 9V. The PRO SOLO must not share an adapter with any other device. Failure to observe this will quite possibly damage the PRO SOLO, other device and and/or the power supply; and **will invalidate your warranty.**

System Diagram

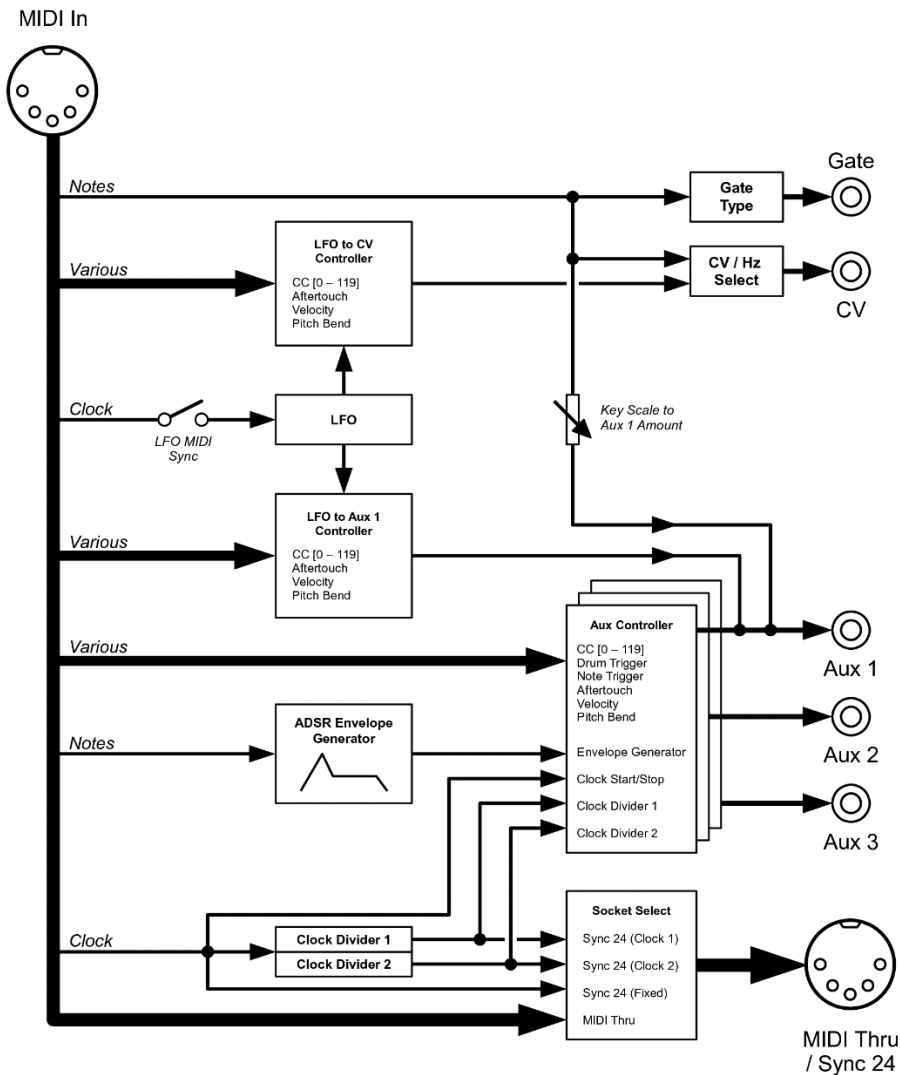

Using multiple Pro Solo Mk3s

If you have more than one Pro Solo Mk3 on the same MIDI port, each should be set with a unique SysEx Device ID – see Parameter 91 on page 25.

Editing Parameters

The PRO SOLO Mk3 has a number of parameters, each with several possible values. Settings are changed by selecting a parameter and then adjusting the value accordingly. To switch between parameter and value modes, briefly press the SELECT button.

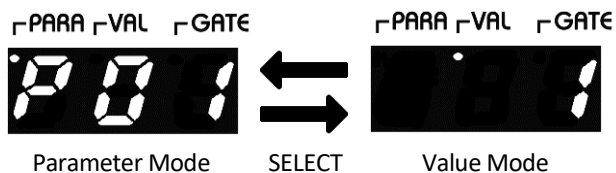

When the PRO SOLO Mk3 is in Parameter Mode, the PARA dot will be lit and “P” will appear in the left digit. The parameter number will be shown in the right two digits. An overview of the parameter list is printed on the PRO SOLO Mk3 itself, although whenever the parameter number is changed, its name will scroll across the display – i.e. “MIDI rec channel”. The full list of parameters and their associated values can be found starting at page 14.

When in value mode, the VAL dot will be lit instead. The value will be displayed across all three digits. A negative value is signified by a minus appearing in the left digit.

The value or parameter can be adjusted using the INC and DEC buttons to scroll through the available options. To increment or decrement the value faster, hold either the INC or DEC button and then press the other.

When you change the value of a parameter, this will be stored in memory and recalled on start-up. The PRO SOLO Mk3 can store and recall 32 sets of parameters, referred to as a setup.

Note: Holding down the SELECT button (as long as the current Parameter is not 98 or 99) will clear any playing note in the event of a ‘stuck note’.

Loading & Storing Setup

One complete set of parameters (except for the 'Other' group) on the PRO SOLO Mk3 is known as a setup, and 32 of them can be stored and recalled.

For example, if you wish to use your PRO SOLO Mk3 with several different synthesizers, you could have different setups for them, each with its own CV/Gate types and tuning settings. Of course, as a setup contains an entire set of parameters, you could also use this to store and recall anything, such as the ADSR settings.

Any value you change is automatically stored to the current setup when changing to Parameter Mode. To save the setup for future use, select a program to write to using Parameter 99 (Store Program). Press and hold the SELECT button for approximately 6 seconds until the display reads [Sto]. The setup has now been saved and can be recalled later.



To load a setup, select Parameter 98 (Load Program) and choose which program to be loaded as the current setup. Press and hold the SELECT button for approximately 6 seconds until the display reads [Lod]. The setup has now been retrieved and is in use.



Tip: You can change the current setup from MIDI Program Change commands by enabling Parameter 97 (MIDI Program Change Receive Enable).

Setting Up Your Synth

Before starting, leave your analogue synthesizer disconnected from the PRO SOLO Mk3. If necessary, give it time to warm up and ensure that it is in tune playing from its own keyboard. Make sure that it's set to a basic patch.

For now, just connect MIDI IN to the MIDI output of your keyboard or sequencer and the CV and GATE outputs to your synthesizer. Set the PRO SOLO Mk3 to the same MIDI channel as your controller, using Parameter 1 (MIDI Receive Channel).

You will need to set the CV and gate type on the PRO SOLO Mk3 to match those of your synthesizer, using Parameters 15 and 16. This information is often printed on the synthesizer, or in its instruction manual. Alternatively, the PRO SOLO Mk3 comes pre-loaded with some setups pre-loaded for specific synthesizers – see page 27.

Try playing a MIDI note - the synthesizer should sound. At this point, don't worry if it is not in tune, although if it is then you can skip the next two steps.

Using **bottom C** on your MIDI controller (note #36) as a reference, adjust the Coarse Tune and Fine Tune settings (Parameters 12 & 13) until your synth is exactly in tune.

When this bottom C is in tune, adjust the Scale (Parameter 14) until it tracks properly up the keyboard. If this is still not the case you may need to repeat the Coarse and Fine Tune adjustments for final tweaking.

Using the Aux Outputs

If your synthesizer has inputs for additional control voltages, such as for filter cut-off or VCA volume, these can also be controlled via MIDI using the PRO SOLO Mk3's three Auxiliary Outputs. Each Aux output has its own Controller, to which a variety of MIDI message types, such as Velocity, Aftertouch, Pitch Bend and CCs can be assigned; as well as a couple of special modes.

You can only select one Controller for each Aux output; however, you can use the same Controller for multiple Aux outputs if you want to send the same signal to several destinations. Aux 1 is a special case in that keyboard scale and the LFO can be routed to it *in addition* to whichever Controller is selected. See the System Diagram on page 5.

Each Aux output has an associated minimum value, maximum value and reset value. The full range of the controller, for example a MIDI CC, will be scaled between the minimum and maximum values. It is possible to set up an inverted response by setting the minimum value higher than the maximum.

The reset value determines the level to which the Aux output will reset to at power-on, upon receiving a MIDI Controller Reset message or loading a new setup.

Example – assigning MIDI note velocity to Aux 1:

Connect AUX 1 to a control input on your synthesizer, such as the filter cut-off. Set Parameter 20 (Aux 1 Controller), to “VL” for MIDI note velocity. Assuming your MIDI controller is velocity sensitive, the timbre produced by the synthesizer will change depending on how hard the note is struck. You may need to adjust the minimum and maximum values (Parameters 21 & 22) to get the desired range of response.

Using the LFO

The PRO SOLO Mk3 has its own internal LFO (low frequency oscillator), which can be used to modulate the CV and/or Aux 1 outputs. The amount of LFO that is sent to each of these destinations can be controlled independently, and is assignable to a variety of Controllers. By default, the LFO is routed to the CV output, providing a vibrato effect when the modulation wheel (CC 1) is turned up.

The rate of the LFO is adjustable from approximately 0.1Hz to 100Hz, and can also be synchronised to incoming MIDI clock with a variable divide ratio. Various waveshapes are available, including triangle, sawtooth, several widths of pulse, as well as a pseudo-random sample-and-hold. The LFO can either be free running or can be reset to a user-specified point in the waveform on key-on.

For a thorough explanation of all of the parameters and values associated with the LFO, please see pages 21 & 22.

Using the ADSR Envelope Generator

New to the PRO SOLO Mk3 is an ADSR envelope generator, which can be assigned to any of the Aux Controllers. This may be of use to owners of synthesizers which only have a very simple envelope generator; or to owners of modular systems who would like an additional envelope without having to buy another module.

The ADSR envelope is controlled using the four parameters shown on the diagram below, but for more hands-on control, you can assign CCs to them, using Parameters 86 to 89.

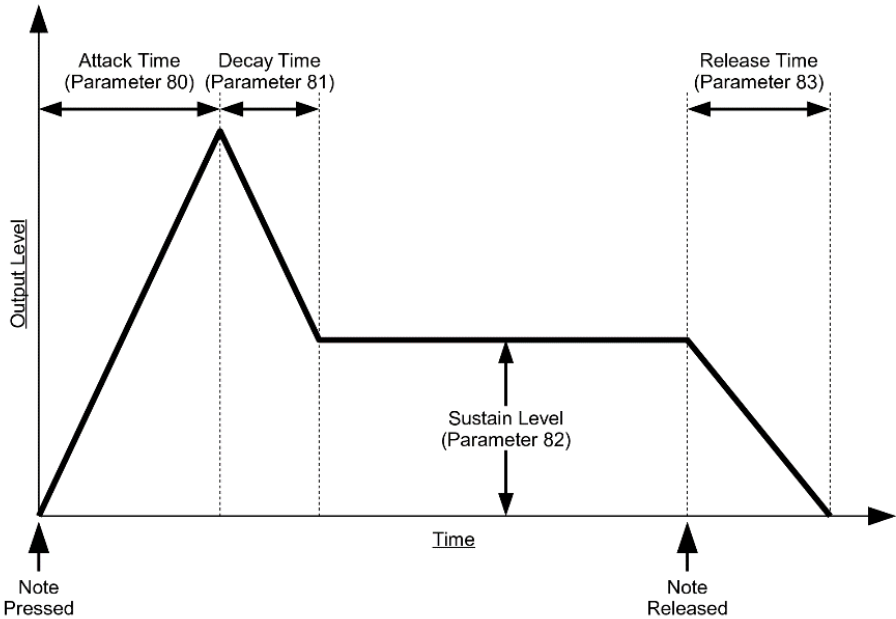

Example – producing an ADSR envelope on Aux 1:

Connect AUX 1 to a control input on your synthesizer, such as the filter cut-off. Set Parameter 20 (Aux 1 Controller) to “Eg”. When a note is triggered, the timbre of the sound will change automatically over time. The attack time, decay time, sustain level and release time can be adjusted using the parameters shown above.

Using the Drum Triggers

One of the possible Aux Controllers is Drum Trigger (“dtr” in the Aux Controller lists). This will cause that Aux output to produce a brief trigger pulse of a user-specifiable length whenever a particular MIDI note is pressed, suitable for triggering a drum synthesizer. The velocity of the note will control the level of the trigger, according to the Aux output’s minimum and maximum value settings.

Which MIDI note each of the three Drum Triggers respond to can be set individually using Parameters 29, 34 and 44; but the trigger length (Parameter 93) is common to all of them.

Using the Note Trigger

Whereas Drum Trigger will produce a pulse when *specific* notes are pressed; Note Trigger (“trg” in the Aux Controller lists) will produce a trigger pulse when *any* note on the current MIDI channel is pressed.

This is included for some synthesizers (mainly vintage ARP models such as the 2600) which require a trigger pulse in addition to a gate signal for their envelope generators.

Using the Clock Outputs

The PRO SOLO Mk3 has two clock dividers, each of which take the incoming MIDI clock and divide it down to a user-specified ratio of pulses per quarter note (ppqn).

The outputs of these dividers are made available in the Aux Controller lists, as well as to the Sync 24 output, as Clock 1 and Clock 2. They are suitable for synchronising drum machines, arpeggiators, sequencers, etc. to MIDI clock.

The clock divide ratio list also includes two special modes, “c24” and “c48”, which are used to produce 24 ppqn clock (used for many drum machines) and 48 ppqn clock (used for Linn, Oberheim and some Korg drum machines).

Example – generating a 16th note clock pulse from Aux 1:

Connect AUX 1 to a clock input on your equipment. Set Parameter 20 (Aux 1 Controller), to “CL1”. Set Parameter 60 (Clock Divide Ratio), to 6. Incoming MIDI clock will produce a 16th note clock output on Aux 1.

On the subject of clock, MIDI Start / Stop is also made available in the Aux Controller lists as “stt”. The output will turn on when the sequence is running, and off when it is stopped.

Using Auto Portamento

If you are using the USB Solo with our 5 socket kits for the MC-202 or TB-303, you can use Auto Portamento to automatically turn on the Roland's own portamento when receiving legato notes, rather than relying on the USB Solo's built in portamento. If using this option, it is advisable to set parameter 5 (Portamento Controller) to "off" to avoid Portamento being applied twice.

Using the Sync 24 Output

The MIDI THRU socket on the PRO SOLO Mk3 can instead be set to output Sync 24 (also known as DIN SYNC), for connecting various pre-MIDI drum machines and other equipment. This is done using Parameter 90 (Socket Select).

When the socket is being used to output Sync 24, there are three possible clock sources. "S24" produces a fixed 24 ppqn output, suitable for clocking equipment such as the Roland TR-808, TR-606, TB-303 and MC-202. Alternatively, the two clock dividers ("CL1" and "CL2") are available as clock sources, so by setting the appropriate divide ratio to "c48", it is possible to sync devices expecting 48 ppqn or indeed any other divide ratio.

Note: If you are having trouble getting MIDI clock to work, start by checking that your sequencer is actually transmitting it – some have this turned off by default, or restricted to a certain MIDI port. Some patch bays and mergers also filter out MIDI clock. The MIDI Analyser mode can be used to confirm whether the PRO SOLO Mk3 is actually receiving MIDI clock – see page 29.

Parameter List – General & Note

P01 **MIDI Receive Channel** (default: 1)

Range: 1 to 16

Sets the MIDI receive channel.

P02 **Re-trigger Time** (default: 5 = 1ms)

Range: [off] and 1 to 25 (0.2ms to 5ms)

If set to off, successive simultaneous notes will not re-trigger the gate, also known as legato triggering. If set to a number, a new note will briefly turn the gate off before turning it back on again. The number relates to the off time in approximately 0.2ms increments.

P03 **Note Priority** (default: New)

[nn]	New note priority
[lo]	Low note priority (lowest note currently pressed)
[hi]	High note priority (highest note currently pressed)

Sets the note priority for when multiple notes are pressed. The PRO SOLO Mk3 has a 5-note buffer memory so trill effects can be achieved.

P04 **Pitch Bend Range** (default: 2)

Range: 0 to ±48 semitones.

Sets how much the CV output will be affected by Pitch Bend, in semitone steps.

P05 **Portamento Controller** (default: 65)

[on]	Always on
[off]	Always off
[Aut]	Automatic (normally off, but legato playing turns it on)
0 to 119	CCs 0 to 119 (value of 0-63 for off and 64-127 for on)

Sets which CC number will turn portamento on or off; or sets to it fixed on, off or Automatic mode.

P06 **Portamento Rate** (default: 98)

Range: 1 to 127 (value does not correspond to any particular unit of time)

Sets how long it takes the CV output to glide from one note to another.

Note: to turn portamento off entirely, set P05 (above) to 0.

P07 **Portamento Type** (default: Fixed Rate)

[Fr]	Fixed rate
[Ft]	Fixed time

Sets the portamento behaviour. In Fixed Rate, the CV will glide between notes at a constant speed, so the time taken will vary depending on their interval. In Fixed Time, the portamento speed will automatically change to ensure that the time taken to glide between notes is constant. (In extreme cases this is not always possible)

Parameter List – General & Note (contd.)

P08 **LFO to CV Controller** (default: 1)

0 to 119	CCs 0 to 119
[Aft]	Aftertouch
[VEL]	Velocity
[Pbd]	Pitch Bend
[off]	Off

Sets which MIDI message will control LFO modulation depth on the CV output.

P09 **LFO to CV Minimum Value** (default: 0)

Range: 0 to 127

Sets the level for LFO to CV modulation when the controller is at its minimum value, allowing for a base level of modulation to be applied at all times. If you play a note while you are changing this value, it is sent to CV so that you can hear the effect of changing this value.

P10 **LFO to CV Maximum Value** (default: 50)

Range: 0 to 127

Sets the level for LFO to CV modulation when the controller is at its maximum value. If you play a note while you are changing this value, it is sent to CV so that you can hear the effect of changing this value.

Tip: Swap the minimum and maximum values so that the controller works backwards.

P11 **LFO to CV Reset Value** (default: 0)

Range: 0 to 127

Sets the amount of LFO to CV modulation that the PRO SOLO Mk3 will reset to at power-on, upon receiving a MIDI Controller Reset message or a new setup being loaded from memory. Use this if you want a pre-set amount of modulation that can later be turned off using the chosen controller. If you play a note while you are changing this value, it is sent to CV so that you can hear the effect of changing this value.

P12 **Coarse Tune / Transpose** (default: 0)

Range: -24 to +24 semitones

Sets the tuning for the CV output in semitone steps. Some synthesizers may be out of adjustment or use a non-standard base tuning, such as the original Minimoog (0V results in an F).

P13 **Fine Tune** (default: 0)

Range: -127 to +127 (approximately a semitone either way)

Sets the fine-tuning for the CV output. All notes are offset by the same amount.

P14 **Scale** (default: 0)

Range: -127 to +127

Sets the octave scaling (aka scale width) for the CV output. Use this if your synthesizer is not tracking correctly. Bottom C (note #36) will not move, so tune the C two octaves above that by using this parameter.

Parameter List – General & Note (contd.)

P15 **CV / Hz Select** (default: CV)

[CV]	1 Volt per Octave
[Hz]	Hz per Volt
[11]	1.1 Volts per Octave
[12]	1.2 Volts per Octave
[13]	1.3 Volts per Octave
[14]	1.4 Volts per Octave
[15]	1.5 Volts per Octave

Sets whether the CV output produces 1V/oct, Hz/Volt or 1.2V/oct control voltage.

P16 **Gate Type** (default: g05)

[g05]	Gate (V-trig) at +5V
[g10]	Gate (V-trig) at +10V
[g15]	Gate (V-trig) at +15V
[S_]	S-trig with no pull-up
[S05]	S-trig with +5V pull-up
[S10]	S-trig with +10V pull-up
[S15]	S-trig with +15V pull-up

Sets the Gate type and output / pull-up voltage.

Parameter List – Aux 1

P20 **Aux 1 Controller** (default: 16)

0 to 119	CCs 0 to 119
[Aft]	Aftertouch
[VEL]	Velocity
[Pbd]	Pitch Bend
[off]	Off (ignores all controllers and outputs Reset Value)
[trg]	Note Trigger
[CL1]	Clock Divider 1
[CL2]	Clock Divider 2
[Stt]	Clock Start / Stop
[dtr]	Drum Trigger
[Eg]	ADSR Envelope
[APo]	Auto Portamento

Sets what Aux 1 will be controlled by.

P21 **Aux 1 Minimum Value** (default: 0)

Range: -27 to +100 (approximately -2.7V to +10.0V)

Sets the level for Aux 1 when the controller is at its minimum level. If you play a note while you are changing this value, it is sent to Aux 1 so that you can hear the effect of changing this value.

P22 **Aux 1 Maximum Value** (default: 100)

Range: -27 to +100 (approximately -2.7V to +10.0V)

Sets the level for Aux 1 when the controller is at its maximum level. If you play a note while you are changing this value, it is sent to Aux 1 so that you can hear the effect of changing this value.

Tip: Swap the minimum and maximum values if you need the controller to work backwards.

P23 **Aux 1 Reset Value** (default: 0)

Range: 0 to 127

Sets the value that Aux 1 will reset to at power-on, upon receiving a MIDI Controller Reset command or a new setup being loaded from memory. This is equivalent to a MIDI message of this value being received, so it will be influenced by the minimum and maximum settings above. If you play a note while you are changing this value, it is sent to Aux 1 so that you can hear the effect of changing this value.

P24 **Key Scale to Aux 1** (default: 0)

Range: 0 to 127

Sets the amount of scaled CV that will be added to the Aux 1 output. Use this for synthesizers which lack keyboard filter tracking when being controlled via external CV.

Parameter List – Aux 1 (contd.)

P25 LFO to Aux 1 Controller (default: 17)

0 to 119	CCs 0 to 119
[Aft]	Aftertouch
[VEL]	Velocity
[Pbd]	Pitch Bend
[off]	Off

Sets which MIDI message will control the amount of LFO modulation output on Aux 1.

P26 LFO to Aux 1 Minimum Value (default: 0)

Range: 0 to 127

Sets the level for LFO to Aux 1 modulation when the controller is at its minimum value, allowing for a base level of modulation to be applied at all times. If you play a note while you are changing this value, it is sent to Aux 1 so that you can hear the effect of changing this value.

P27 LFO to Aux 1 Maximum Value (default: 64)

Range: 0 to 127

Sets the level for LFO to Aux 1 modulation when the controller is at its maximum value. If you play a note while you are changing this value, it is sent to Aux 1 so that you can hear the effect of changing this value.

Tip: Swap the minimum and maximum values if you need the controller to work backwards.

P28 LFO to Aux 1 Reset Value (default: 0)

Range: 0 to 127

Sets the amount of LFO to Aux 1 modulation that the PRO SOLO Mk3 will reset to at power-on, upon receiving a MIDI Controller Reset command or a new setup being loaded from memory. Use this if you want a pre-set amount of modulation that can later be turned off using the chosen controller. This is equivalent to a MIDI message of this value being received, so it will be influenced by the minimum and maximum settings above. If you play a note while you are changing this value, it is sent to Aux 1 so that you can hear the effect of changing this value.

P29 Aux 1 Drum Trigger Note (default: 60)

Range: 0 to 127

Sets which note Aux 1 will respond to if controller is set to Drum Trigger.

Parameter List – Aux 2

P30 **Aux 2 Controller** (default: 7)

0 to 119	CCs 0 to 119
[Aft]	Aftertouch
[VEL]	Velocity
[Pbd]	Pitch Bend
[off]	Off (ignores all controllers and outputs Reset Value)
[trg]	Note Trigger
[CL1]	Clock Divider 1
[CL2]	Clock Divider 2
[Stt]	Clock Start / Stop
[dtr]	Drum Trigger
[Eg]	ADSR Envelope
[APo]	Auto Portamento

Sets what Aux 2 will be controlled by.

P31 **Aux 2 Minimum Value** (default: 0)

Range: -27 to +100 (approximately -2.7V to +10.0V)

Sets the level for Aux 2 when the controller is at its minimum level. If you play a note while you are changing this value, it is sent to Aux 2 so that you can hear the effect of changing this value.

P32 **Aux 2 Maximum Value** (default: 100)

Range: -27 to +100 (approximately -2.7V to +10.0V)

Sets the level for Aux 2 when the controller is at its maximum level. If you play a note while you are changing this value, it is sent to Aux 2 so that you can hear the effect of changing this value.

Tip: Swap the minimum and maximum values if you need the controller to work backwards.

P33 **Aux 2 Reset Value** (default: 127)

Range: 0 to 127

Sets the value that Aux 2 will reset to at power-on, upon receiving a MIDI Controller Reset command or a new setup being loaded from memory. This is equivalent to a MIDI message of this value being received, so it will be influenced by the minimum and maximum settings above. If you play a note while you are changing this value, it is sent to Aux 2 so that you can hear the effect of changing this value.

P34 **Aux 2 Drum Trigger Note** (default: 61)

Range: 0 to 127

Sets which note Aux 2 will respond to if controller is set to Drum Trigger.

Parameter List – Aux 3

P40 **Aux 3 Controller** (default: Velocity)

0 to 119	CCs 0 to 119
[Aft]	Aftertouch
[VEL]	Velocity
[Pbd]	Pitch Bend
[off]	Off (ignores all controllers and outputs Reset Value)
[trg]	Note Trigger
[CL1]	Clock Divider 1
[CL2]	Clock Divider 2
[Stt]	Clock Start / Stop
[dtr]	Drum Trigger
[Eg]	ADSR Envelope
[APo]	Auto Portamento

Sets what Aux 3 will be controlled by.

P41 **Aux 3 Minimum Value** (default: 0)

Range: 0 to +100 (approximately 0V to +10.0V)

Sets the level for Aux 3 when the controller is at its minimum level. If you play a note while you are changing this value, it is sent to Aux 3 so that you can hear the effect of changing this value.

P42 **Aux 3 Maximum Value** (default: 100)

Range: 0 +100 (approximately 0V to +10.0V)

Sets the level for Aux 3 when the controller is at its maximum level. If you play a note while you are changing this value, it is sent to Aux 3 so that you can hear the effect of changing this value.

Tip: Swap the minimum and maximum values if you need the controller to work backwards.

P43 **Aux 3 Reset Value** (default: 0)

Range: 0 to 127

Sets the value that Aux 3 will reset to at power-on, upon receiving a MIDI Controller Reset command or a new setup being loaded from memory. This is equivalent to a MIDI message of this value being received, so it will be influenced by the minimum and maximum settings above. If you play a note while you are changing this value, it is sent to Aux 3 so that you can hear the effect of changing this value.

P44 **Aux 3 Drum Trigger Note** (default: 62)

Range: 0 to 127









Sets which note Aux 3 will respond to if controller is set to Drum Trigger.

Parameter List – LFO

P50 **LFO Rate / Speed** (default: 116 – approximately 6.25Hz)
Range: 0 to 191 (approximately 0.1Hz to 100Hz logarithmic)

Sets the speed of the LFO. The value increment is not calibrated to any specific unit.

P51 **LFO Waveshape** (default: Triangle)

[TR]	Triangle		[SU]	Sawtooth up	
[SD]	Sawtooth down		[10]	10% Pulse	
[20]	20% Pulse		[30]	30% Pulse	
[40]	40% Pulse		[50]	Square	
[SH]	Sample & Hold <i>(Pseudo-random, new level for each trigger)</i>				

Sets the waveshape of the LFO. All waveshapes modulate CV and/or Aux 1 to any value between 0 to a positive value except triangle, which modulates positive and negative. The downward arrow indicates the default start point, which can be changed with Parameter 53.

Parameter List – LFO (contd.)

P52 **LFO MIDI Sync** (default: Off)

Range: [off], 1 to 96.

Sets whether the LFO is synchronised to MIDI clock, and if so, the divide ratio. The LFO waveform will automatically adjust its length so that it will start at the beginning of a bar, and last for whatever musical time it is set for (see below for divide ratios).

A divide ratio can be set so the LFO only re-triggers every so many MIDI clock messages. MIDI sends 24 clocks per quarter note. If divide is set to 1, there will be 1 cycle of the LFO for every 1 MIDI clock. (i.e. 24 cycles per quarter note). If set to 24, there will be 1 cycle of the LFO for every 24 MIDI clocks. (i.e. 1 cycle of the LFO per quarter note).

Note type	Divide ratio
Semibreve (whole note)	96
Minim (half note)	48
Crotchets (quarter note)	24
Crotchet triplets	16
Quavers (8 th note)	12
Quaver triplets	8
Semiquaver (16 th note)	6
Semiquaver triplets	4
Demisemiquavers (32 nd note)	3
Demisemiquaver triplets	2

Note: It is recommended that you do not use low divide ratios at high clock speeds (particularly 1), and switch LFO Sync off if you are not currently using it.

P53 **LFO Sync Start Point** (default: 0)

Range: 0 to 255

Sets where the LFO waveform will start from when MIDI Sync or Key-On Reset is enabled.

P54 **LFO Key-On Reset** (default: Off)

Range: Off or On

Sets whether the LFO waveform will reset to its starting point whenever a new note is played.

Parameter List – Clock

P60 **Clock 1 Divide Ratio (default: d2)**

[d2] to [d24]	Divide ratio of 2 to 24 (see below)
[c24]	24 ppqn
[c48]	48 ppqn

Sets the ratio of incoming MIDI clock messages to outgoing clock pulses.

Note type	Divide ratio	ppqn (pulses per quarter note)
Crotchets (quarter note)	24	1
Crotchet triplets	16	
Quavers (8 th note)	12	2
Quaver triplet	8	
Semiquaver (16 th note)	6	4
Semiquaver triplets	4	6
Demisemiquavers (32 nd note)	3	8
Demisemiquaver triplets	2	12

P61 **Clock 1 Shift (default: 0)**

Range: 0 to 255

Shifts the entire clock output cycle in steps determined by the incoming MIDI clock rate. Low values can be used to make Clock 1 and Clock 2 out of phase with each other, while higher values can be used to delay the start of one clock relative to the other. This setting only takes effect immediately after receiving a MIDI Start or Continue message - it has no effect if the MIDI clock has already been started.

P70 **Clock 2 Divide Ratio (default: d2)**

[d2] to [d24]	Divide ratio of 2 to 24 (see below)
---------------	-------------------------------------

Sets the ratio of incoming MIDI clock messages to outgoing clock pulses. See divide ratio table above.

P71 **Clock 2 Shift (default: 0)**

Range: 0 to 255

Shifts the entire clock output cycle in steps determined by the incoming MIDI clock rate. Low values can be used to make Clock 1 and Clock 2 out of phase with each other, while higher values can be used to delay the start of one clock relative to the other. This setting only takes effect immediately after receiving a MIDI Start or Continue message - it has no effect if the MIDI clock has already been started.

Parameter List – ADSR Envelope Generator

P80 **EG Attack Time** (default: 40)

Range: 0 to 127 (approximately 0 to 3.57 seconds)

Sets the time for the attack phase of the ADSR envelope.

P81 **EG Decay Time** (default: 40)

Range: 0 to 127 (approximately 0 to 3.57 seconds)

Sets the time for the decay phase of the ADSR envelope.

P82 **EG Sustain Level** (default: 64)

Range: 0 to 127

*Sets the level the ADSR envelope will sustain at.
This phase will be held if the Sustain Pedal (CC 64) is pressed.*

P83 **EG Release Time** (default: 40)

Range: 0 to 127 (approximately 0 to 3.57 seconds)

Sets the time for the release phase of the ADSR envelope.

P84 **EG Invert** (default: Off)

Range: Off or On

Sets whether or not the ADSR envelope will be inverted – i.e. envelope will start at its maximum level.

P85 **EG Reset to Zero** (default: On)

Range: Off or On

Sets whether or not new notes will cause the envelope to reset to its starting point if it has not completed its cycle; otherwise it will continue at its previous level.

Parameter List – ADSR Envelope Generator (contd.)

P86 **EG Attack Time CC (default: 20)**

Range: 0 to 119

Sets which CC will control the ADSR attack time.

P87 **EG Decay Time CC (default: 21)**

Range: 0 to 119

Sets which CC will control the ADSR decay time.

P88 **EG Sustain Level CC (default: 22)**

Range: 0 to 119

Sets which CC will control the ADSR sustain level.

P89 **EG Release Time CC (default: 23)**

Range: 0 to 119

Sets which CC will control the ADSR release time.

Parameter List – Other

P90 **Socket Select (default: MIDI Thru)**

[MO]	MIDI Thru (and Out for SysEx program dump)
[S24]	Sync 24 (fixed at 24 ppqn)
[CL1]	Sync 24 (using Clock Divider 1)
[CL2]	Sync 24 (using Clock Divider 2)

Sets the function of the MIDI Thru / Sync 24 socket.

P91 **SysEx Device ID (default: 1)**

Range: 1 to 16

Sets the MIDI SysEx device ID for this unit.

P92 **Continue = Start (default: On)**

Range: Off or On

Sets how MIDI Continue messages are treated. When turned on, these messages are treated as if they were MIDI Start messages. When turned off, Continue messages will only be treated as Start if immediately preceded by a Song Position Pointer = 0 message. (Some sequencers use this instead of a start message)

Note: This parameter affects the Sync 24 output as well as the Clock Start / Stop Aux Controller.

Parameter List – Other (contd.)

P93 **Drum Trigger Length** (default: 80)

Range: 0 to 127 (each increment represents approximately 45.7 μ s, for a maximum length of 5.8ms)

Sets the duration of the output pulse when Drum Trigger is being used as a controller.

P94 **Aux 1 Slew Rate** (default: 0)

Range: 0 to 31

Sets the slew rate or granularity of the Aux 1 Controller. This parameter can be used to smooth out a steppy response from CCs at the expense of a time delay.

P95 **Aux 2 Slew Rate** (default: 0)

Range: 0 to 31

As above.

P96 **Aux 3 Slew Rate** (default: 0)

Range: 0 to 31

As above.

P97 **Program Change Receive Enable** (default: Off)

Range: Off or On

Sets whether or not MIDI Program Change messages can be used to change the current Setup.

P98 **Load Program**

Range: 1 to 32

Sets the program to be loaded as the current Setup. Having selected a program to load, hold the SELECT button for approximately 6 seconds until "Lod" appears in the display.

P99 **Store Program**

Range: 1 to 32

Sets the program into which the current setup will be saved. Having selected a program to save to, hold the SELECT button for approximately 6 seconds until "Sto" appears in the display.

Factory Defaults

To reset the PRO SOLO Mk3 to its factory default settings, hold down all three buttons whilst turning on the power. The display will show “Fd” to show that it has been done.

From the factory or following the above reset procedure, programs 1 to 26 are all loaded with the default setup for use with a Roland SH-101. This setup is also suitable for a lot of other standard CV / Gate synthesizers, including the majority of modern equipment.

The following programs for other synthesizers are loaded into the following locations:

Prog	Synthesizer	Changes from default setup
#32	Roland SH-09 (also Moog Prodigy Mk1 w/ Kenton skts)	Gate 15V
#31	Minimoog (original model)	S-trig, coarse tune -5 semitones
#30	Other Moog	S-trig, coarse tune zero
#29	Korg MS-10 & MS-20	S-trig, Hz/V
#28	Yamaha CS-10	S-trig with 5V pullup, Hz/V
#27	ARP 2600 (also Odyssey Mk1 w/ Kenton skts)	Gate 15V, Aux 2 set to Note Trig

Note: A comprehensive list of what settings to use with which synthesizer, as well as the required leads and any other instrument-specific notes can be found on our website at:
www.kenton.co.uk/synthselector

Check Firmware Version

To see what version of the firmware your PRO SOLO Mk3 is running, turn on the power whilst holding down the INC button (and keep it held). The four-digit firmware number is displayed as two pairs of digits, with the vertical position of the bar in the left-hand digit representing which is currently being shown.



Example: Firmware version v1010

Firmware Upgrade

The PRO SOLO Mk3 firmware can be upgraded using the firmware manager at <https://www.kenton.co.uk/support/apps/>

Alternatively, it can be sent to the PRO SOLO Mk3 via MIDI from a computer as a SysEx message, available at <https://kenton.co.uk/product-category/firmware-flash-updates/>. Full instructions are included in the firmware update zip file.

MIDI Analyser

The PRO SOLO Mk3 has a built-in MIDI analyser function. This feature allows you to see what types of MIDI messages are being transmitted by your master keyboard / sequencer, making the PRO SOLO Mk3 a useful diagnostic tool.

To enter Analyser Mode, power on the PRO SOLO Mk3 whilst holding the SELECT button. The display will show “Anl”, followed by “rc” when you release the button.

The MIDI analyser has several different modes, each of which will respond to a particular MIDI message or group of messages, and are accessed by pressing or holding the buttons:

SELECT, short press	[rc]	Receive Channel & Status
SELECT, long press	[PC]	Program Change
DEC, short press	[nt]	Note Number
DEC, long press	[nv]	Velocity
INC, short press	[Cn]	CC Number
INC, long press	[Cv]	CC Value

‘Receive Channel & Status’ will display the channel of the last MIDI message received in the right two digits. The segments of the left digit blink to show incoming MIDI messages:

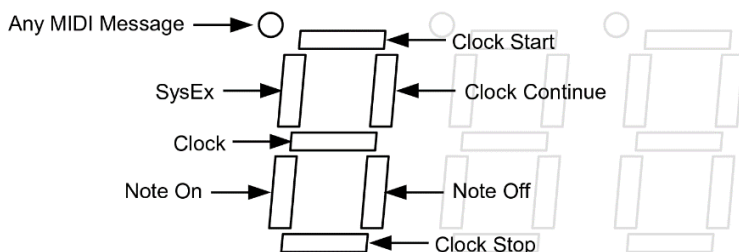

The other modes will simply display across all of the digits the last received MIDI message of the selected type. Pitch Bend and Aftertouch are shown with the CCs, although they are technically a different message type. In all modes, the PARA dot will blink with any MIDI message type.

If a SysEx message is received, “SE” will be displayed.

To exit the MIDI Analyser mode, power the PRO SOLO Mk3 off and on again.

MIDI Implementation

Message Type	Recognised
Note Number	0 to 127
Note-On Velocity	0 to 127
Note-Off Velocity	Not recognised
Pitch Bend	0 to 16383
Aftertouch (Polyphonic)	Not recognised
Aftertouch (Channel)	0 to 127
Control Change (CCs)	CCs 0 to 119 (user assignable), value 0 to 127 CC 64 (Sustain Pedal) will hold gate and ADSR sustain phase
Controller Reset (CC 121 = 0)	Recognised – will set LFO to CV Amount, LFO to Aux 1 Amount, Aux 1, Aux 2 & Aux 3 to their reset values; turn Portamento off (unless set to fixed ON), turn Sustain off, and set Pitch Bend to the centre.
All Notes Off (CC 123 = 0) <i>(also CCs 124 to 127 = 0)</i>	Recognised – will clear playing note and note buffer, and turn the Gate off.
Program Change	0 to 31 (if enabled)
MIDI Clock, Start, Continue, Stop	Recognised
System Exclusive (SysEx)	Firmware Version Request Firmware Version Receive Serial Number Request Serial Number Receive Program Dump Request Program Dump Receive Info Change Firmware Upgrade Detailed explanation of SysEx implementation can be found online at https://kenton.co.uk/support/manuals

Specifications

Power Input	9V DC (regulated or unregulated) – never apply more than 12V (never use an unregulated supply greater than 9V as unregulated supplies typically give a higher output than shown)
Power	100mA, 2.1mm plug (centre positive)
MIDI	In, Thru (Out) on DIN sockets
Analogue Outputs	CV (V/oct, Hz/Volt or 1.2V/oct) on 3.5mm mono jack Gate (Gate or S-trig) on 3.5mm mono jack Aux 1 on 3.5mm mono jack Aux 2 on 3.5mm mono jack Aux 3 on 3.5mm mono jack
Digital Outputs	Sync 24 on pins 1 & 3 of DIN socket (pin 1 = start/stop, pin 3 = clock)
Weight	210g
Dimensions	140mm x 87mm x 45mm
D to A conversion (main CV)	16-bit
D to A conversion (Aux 1 & 2)	12-bit
D to A conversion (Aux 3)	10-bit
Non-volatile memory	EEPROM (no backup battery required)
Processor	32-bit ARM processor

Warranty

The PRO SOLO Mk3 comes with a 12 month (from purchase date) back to base warranty, (i.e. customer must arrange and pay for carriage to and from Kenton Electronics).

KENTON

Unit 3, Epsom Downs Metro Centre, Waterfield, Tadworth, KT20 5LR, UK
+44 (0)20 8544 9200 www.kenton.co.uk tech@kenton.co.uk

firmware rev# 2008

e. & o. e. © 2nd April 2026